

[1] GUILHERME KUMASAKA (HIP)

[1] GUILHERME PARDO (ECP)

[1] GUILHERME KUMASAKA (HIP)

[1] GUILHERME PARDO (ECP)

bye

21.03

16H00

WO	WO		
21	21		

FABRICIO DUARTE (HIP)

RODRIGO AGUERA (HIP)

GUILHERME CAMPOS (BME)

RAFAEL AURICHIO (BME)

21.03	9	8	
11H30	21	21	

FABRICIO DUARTE (HIP)

RODRIGO AGUERA (HIP)

FABRICIO DUARTE (HIP)

RODRIGO AGUERA (HIP)

FILIFE TOLEDO (CAP)

HUGO ARTHUSO (CAP)

FILIFE TOLEDO (CAP)

HUGO ARTHUSO (CAP)

bye

21.03

16H00

21	21		
11	10		

FILIFE TOLEDO (CAP)

HUGO ARTHUSO (CAP)

EMILIO HOFFMANN (C.C)

FERNANDO SATO (C.C)

21.03	17	21	21
11H30	21	10	16

EMILIO HOFFMANN (C.C)

FERNANDO SATO (C.C)

EMERSON JERONIMO (BFP)

VALDECIR BARBOSA (BFP)

HENRIQUE GROTA (FON)

RAFAEL COUTO (FON)

21.03	17	21	21
11H30	21	17	13

HENRIQUE GROTA (FON)

RAFAEL COUTO (FON)

MASSAMI KAMIGASHIMA (BBC)

PABLO SCHOEFFEL (BBC)

21.03

16H00

6	17		
21	21		

LUCAS ARAUJO (HIP)

LUIS MARTIN (HIP)

LUCAS COPI (BME)

RODRIGO WANG (BME)

21.03	8	4	
11H30	21	21	

LUCAS ARAUJO (HIP)

LUIS MARTIN (HIP)

LUCAS ARAUJO (HIP)

LUIS MARTIN (HIP)

JEFFERSON YIN (C.C)

PEDRO CHEN (C.C)

21.03	21	21	
11H30	16	11	

JEFFERSON YIN (C.C)

PEDRO CHEN (C.C)

APOE SOL MANARA (FMB)

MATHEUS ROCHA (FMB)

21.03

16H00

17	13		
21	21		

FERNANDO BOSCO (HIP)

LUIS CEREDA (HIP)

bye

[2] FERNANDO BOSCO (HIP)

[2] LUIS CEREDA (HIP)

[2] FERNANDO BOSCO (HIP)

[2] LUIS CEREDA (HIP)

FILIFE TOLEDO (CAP)

HUGO ARTHUSO (CAP)

22.03

10H20

5	22	8	
21	20	21	

FILIFE TOLEDO (CAP)

HUGO ARTHUSO (CAP)

22.03

13H40

15	21	17	
21	18	21	

1º LUCAS ARAUJO (HIP)

LUIS MARTIN (HIP)

2º FILIFE TOLEDO (CAP)

HUGO ARTHUSO (CAP)

3º FABRICIO DUARTE (HIP)

RODRIGO AGUERA (HIP)

3º FERNANDO BOSCO (HIP)

LUIS CEREDA (HIP)

LUCAS ARAUJO (HIP)

LUIS MARTIN (HIP)

22.03

10H20

22	21		
20	18		

CAMPEONATO NACIONAL DE CURITIBA - ABERTO - 2009

DF

4

[1] FABIANA DA SILVA (HIP)

[1] PAULA BEATRIZ (HIP)

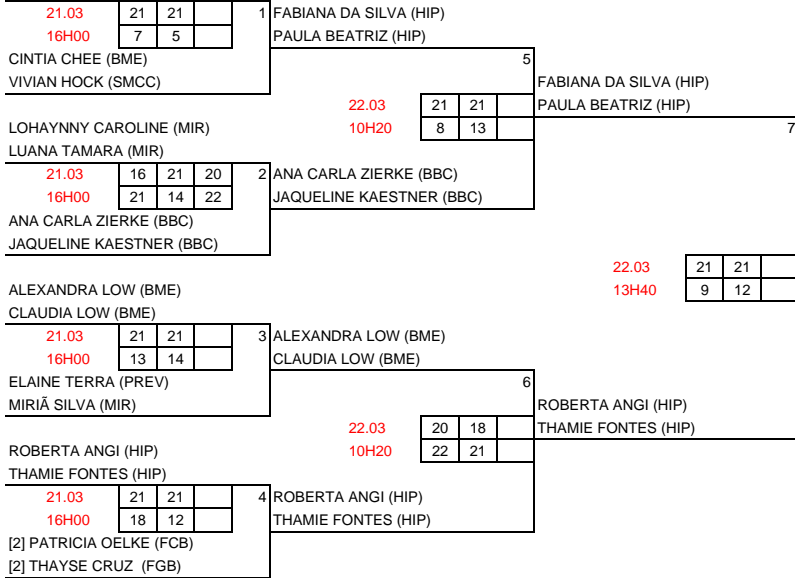

- | | |
|----|--|
| 1º | FABIANA DA SILVA (HIP)
PAULA BEATRIZ (HIP) |
| 2º | ROBERTA ANGI (HIP)
THAMIE FONTES (HIP) |
| 3º | ANA CARLA ZIERKE (BBC)
JAQUELINE KAESTNER (BBC) |
| 3º | ALEXANDRA LOW (BME)
CLAUDIA LOW (BME) |

CAMPEONATO NACIONAL DE CURITIBA - ABERTO - 2009

DX

5

[1] LUCAS ARAUJO (HIP)

[1] ROBERTA ANGI (HIP)

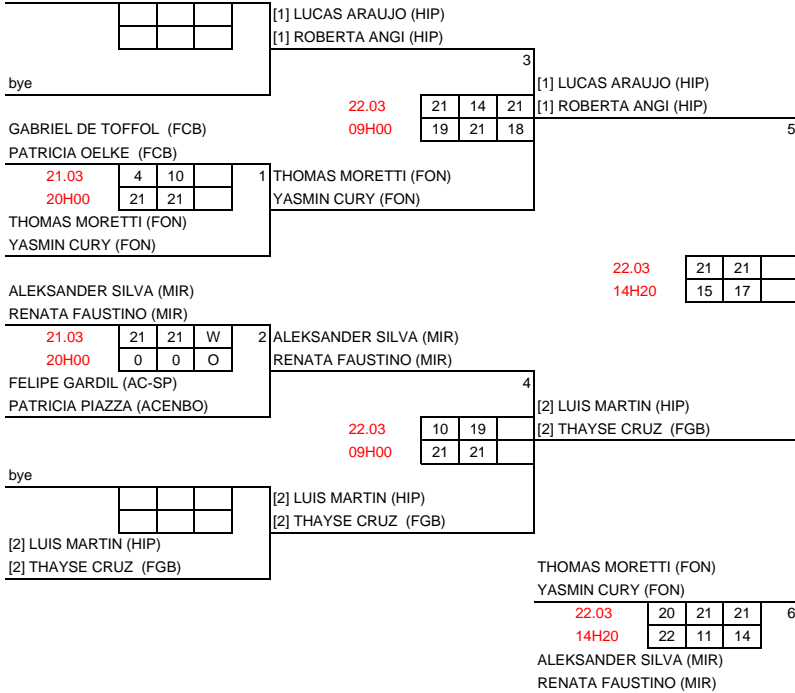

- | | |
|----|---|
| 1º | LUCAS ARAUJO (HIP)
ROBERTA ANGI (HIP) |
| 2º | LUIS MARTIN (HIP)
THAYSE CRUZ (HIP) |
| 3º | THOMAS MORETTI (FON)
YASMIN CURY (FON) |

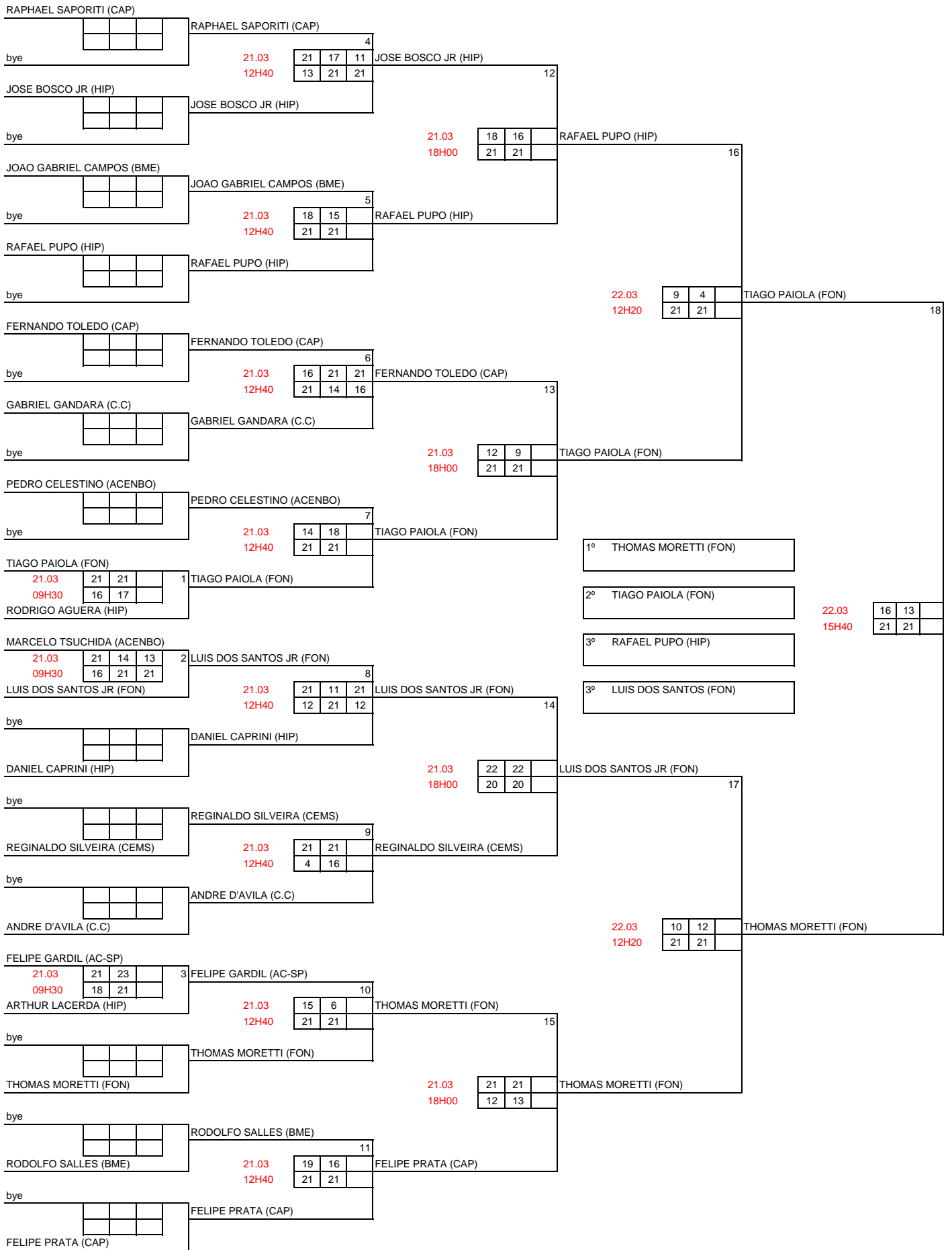

CAMPEONATO NACIONAL DE CURITIBA - ABERTO - 2009

SF Sub-19

7

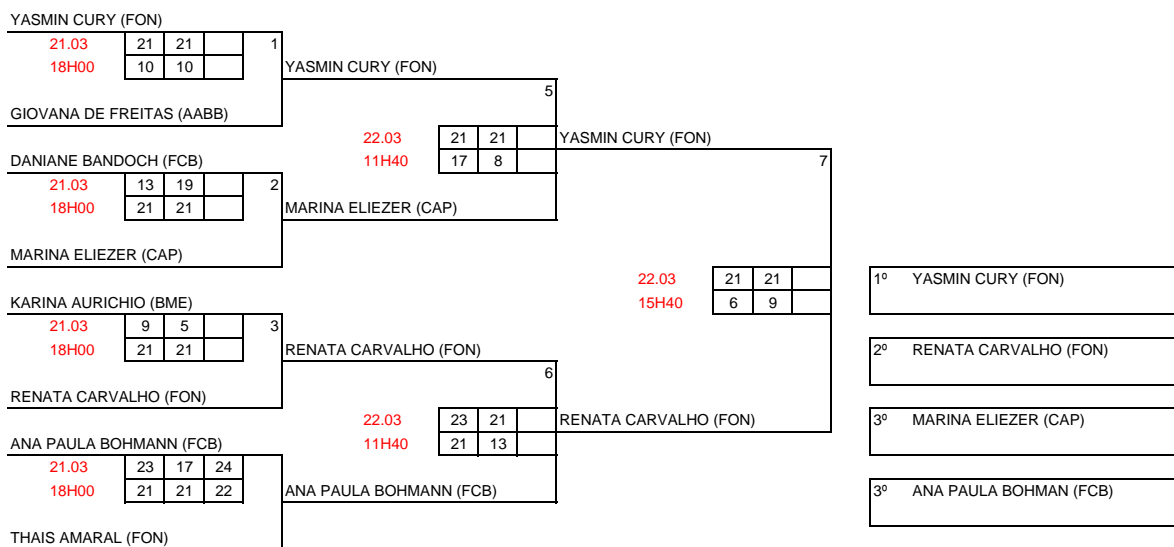

CAMPEONATO NACIONAL DE CURITIBA - ABERTO - 2009

DM Sub-19

8

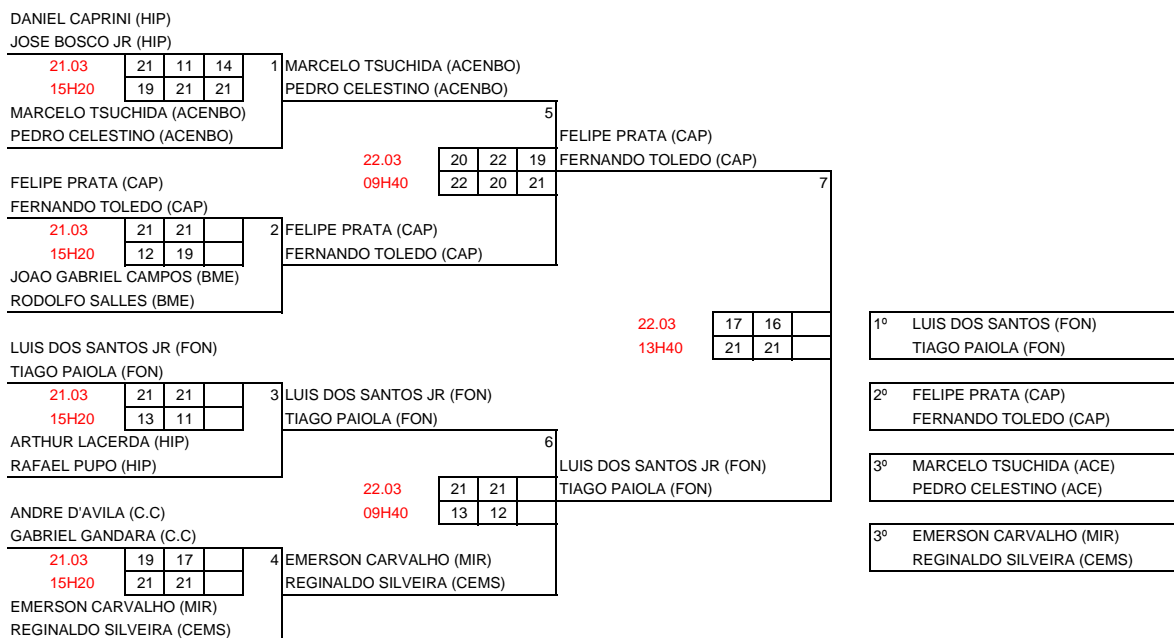

ANA PAULA BOHMANN (FCB)
DANIANE BANDOCH (FCB)

ANA PAULA BOHMANN (FCB)
DANIANE BANDOCH (FCB)

2

bye

22.03
09H40

19	14	
21	21	

GIOVANA DE FREITAS (AABB)
THAIS AMARAL (FON)

GIOVANA DE FREITAS (AABB)
THAIS AMARAL (FON)

GIOVANA DE FREITAS (AABB)
THAIS AMARAL (FON)

4

bye

22.03
13H40

19	21	21
21	19	15

1º GIOVANA DE FREITAS (AABB)
THAIS AMARAL (FON)

FRANCIELLE BALTHAZAR (BME)
KARINA AURICHIO (BME)

21.03
14H40

10	7	
21	21	

1 ANA PAULA CAMPOS (FON)
RENATA CARVALHO (FON)

3

ANA PAULA CAMPOS (FON)
RENATA CARVALHO (FON)

22.03
09H40

21	21	
5	9	

ANA PAULA CAMPOS (FON)
RENATA CARVALHO (FON)

2º ANA PAULA CAMPOS (FON)
RENATA CARVALHO (FON)

bye

ANNA LUISA SANTANA (CAP)
MARINA ELIEZER (CAP)

ANNA LUISA SANTANA (CAP)
MARINA ELIEZER (CAP)

22.03
13H40

17	21	21
21	11	8

ANA PAULA BOHMANN
DANIANE BANDOCH

3º ANNA LUISA SANTANA (CAP)
MARINA ELIEZER (CAP)

5

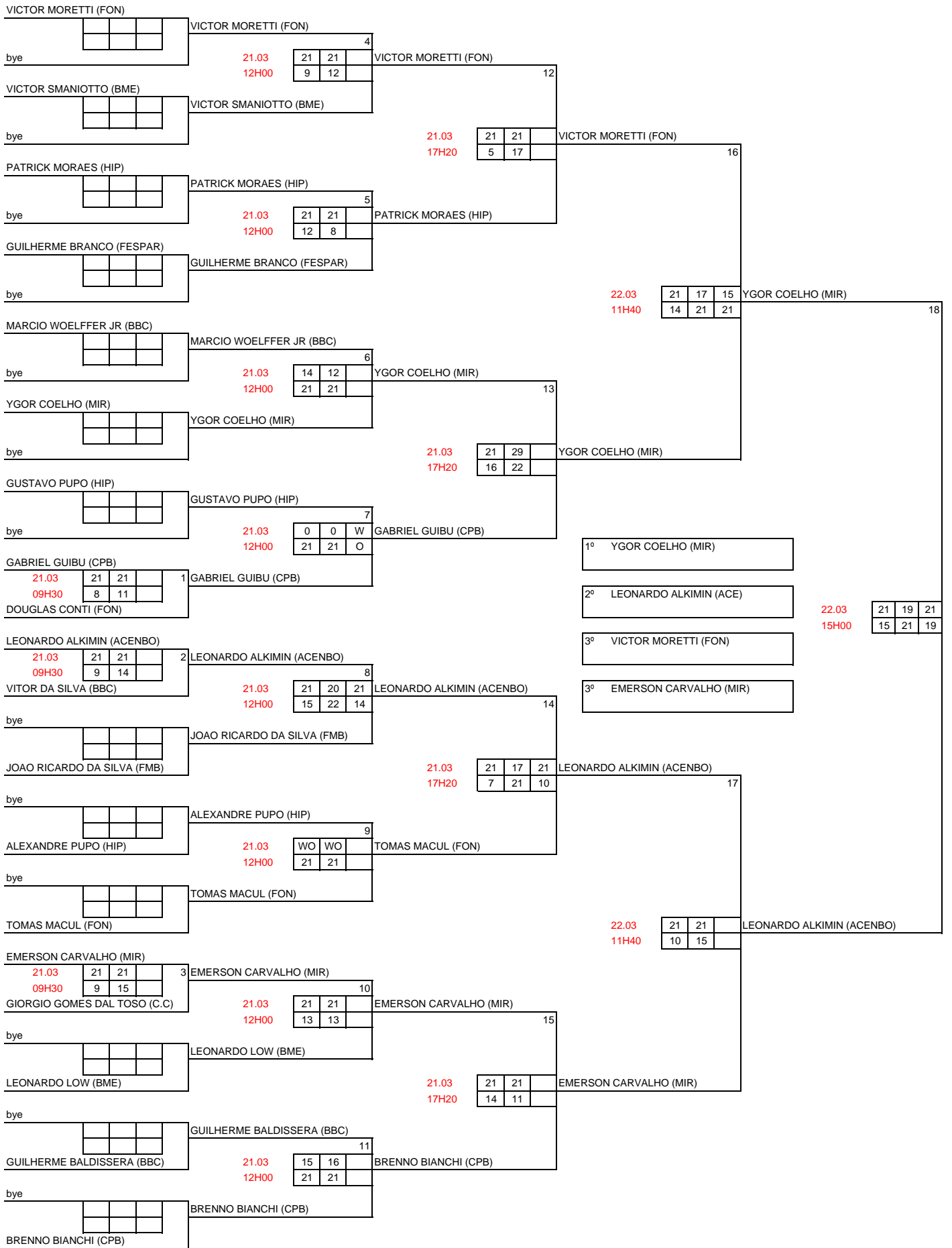

CAMPEONATO NACIONAL DE CURITIBA - ABERTO - 2009

SF Sub-17

11

ISABELA HAUER (BME) 21.03 7 7 1 17H20 21 21	ANA PAULA CAMPOS (FON) 5		
ANA PAULA CAMPOS (FON) 22.03 21 21 11H00 15 13	ANA PAULA CAMPOS (FON) 7		
BRUNA CAVALCANTI (NIK) 21.03 21 21 2 17H20 5 11	BRUNA CAVALCANTI (NIK) 6		
FRANCIELLE BALTHAZAR (BME)			
MIRIÃ SILVA (MIR) 21.03 24 15 3 17H20 26 21	ANNA LUISA SANTANA (CAP) 6	22.03 21 21 15H00 15 10	1º ANA PAULA CAMPOS (FON)
ANNA LUISA SANTANA (CAP)			2º ANNA LUISA SANTANA (CAP)
PAULA PUPO (HIP) 21.03 21 21 4 17H20 18 14	PAULA PUPO (HIP) 6	22.03 21 21 11H00 8 16	3º BRUNA CAVALCANTI (NIK)
ANDRESSA CHANEIKO (BME)			3º PAULA PUPO (HIP)

CAMPEONATO NACIONAL DE CURITIBA - ABERTO - 2009

DM Sub-17

12

DOUGLAS CONTI (FON) TOMAS MACUL (FON)	DOUGLAS CONTI (FON) TOMAS MACUL (FON) 4		
bye		22.03 21 21 09H40 11 13	
GIORGIO GOMES DAL TOSO (C.C) GUILHERME BRANCO (FESPAR) 21.03 21 21 w 1 15H20 0 0 o	GIORGIO GOMES DAL TOSO (C.C) GUILHERME BRANCO (FESPAR) 6		
ALEXANDRE PUPO (HIP) GUSTAVO PUPO (HIP)			
GUILHERME BALDISSERA (BBC) MARCIO WOELFFER JR (BBC) 21.03 11 12 2 15H20 21 21	LEONARDO ALKIMIN (ACENBO) VICTOR MORETTI (FON) 5	22.03 19 14 13H00 21 21	1º LEONARDO ALKIMIN (ACENBO) VICTOR MORETTI (FON)
LEONARDO ALKIMIN (ACENBO) VICTOR MORETTI (FON)			2º DOUGLAS CONTI (FON) TOMAS MACUL (FON)
GIOVANE BROGLIO (HIP) PATRICK MORAES (HIP) 21.03 24 21 3 15H20 22 12	GIOVANE BROGLIO (HIP) PATRICK MORAES (HIP) 5	22.03 21 21 09H40 8 15	
LEONARDO LOW (BME) VICTOR SMANIOTTO (BME)			
	GIOVANE BROGLIO (HIP) PATRICK MORAES (HIP) 7	22.03 21 19 17 13H00 17 21 21	3º GIORGIO GOMES DAL TOSO (C.C.) GUILHERME BRANCO (FESPAR)
	GIORGIO GOMES DAL TOSO (C.C) GUILHERME BRANCO (FESPAR)		

CAMPEONATO NACIONAL DE CURITIBA - ABERTO - 2009

DF Sub-17

13

GABRIELA DOS SANTOS (HIP) PAULA PUPO (HIP) 21.03 21 21 1 14H40 6 14	ANDRESSA CHANEIKO (BME) ISABELA HAUER (BME) 22.03 21 21 2 09H40 18 12	ANDRESSA CHANEIKO (BME) ISABELA HAUER (BME) 22.03 12 23 3 13H00 21 25	1º GABRIELA DOS SANTOS (HIP) PAULA PUPO (HIP)
NAIRA BEATRIZ VIER (BBC) SABINE BREHMER (BBC)	NAIRA BEATRIZ VIER (BBC) SABINE BREHMER (BBC)	GABRIELA DOS SANTOS (HIP) PAULA PUPO (HIP)	2º ANDRESSA CHANEIKO (BME) ISABELA HAUER (BME)
			3º NAIRA BEATRIZ VIER (BBC) SABINE BREHMER (BBC)

CAMPEONATO NACIONAL DE CURITIBA - ABERTO - 2009

DX Sub-17

14

JOAO RICARDO DA SILVA (FMB)
 MARIANA DE FREITAS (AABB)

21.03	21	21			1
20H00	9	17			

BARBARA BANDOCH (FCB)
 MATHEUS MUELLER (FCB)

BRUNA CAVALCANTI (NIK)
 YGOR COELHO (MIR)

22.03	21	21			2
09H00	10	5			

BARBARA BANDOCH (FCB)
 MATHEUS MUELLER (FCB)

BRUNA CAVALCANTI (NIK)
 YGOR COELHO (MIR)

22.03	13	21	21		3
13H40	21	15	17		

JOAO RICARDO DA SILVA (FMB)
 MARIANA DE FREITAS (AABB)

1º	BRUNA CAVALCANTI (NIK) YGOR COELHO (MIR)
----	---

2º	JOÃO RICARDO (FMB) MARIANA DE FREITAS (AABB)
----	---

3º	BARBARA BANDOCH (FCB) MATHEUS MUELLER (FCB)
----	--

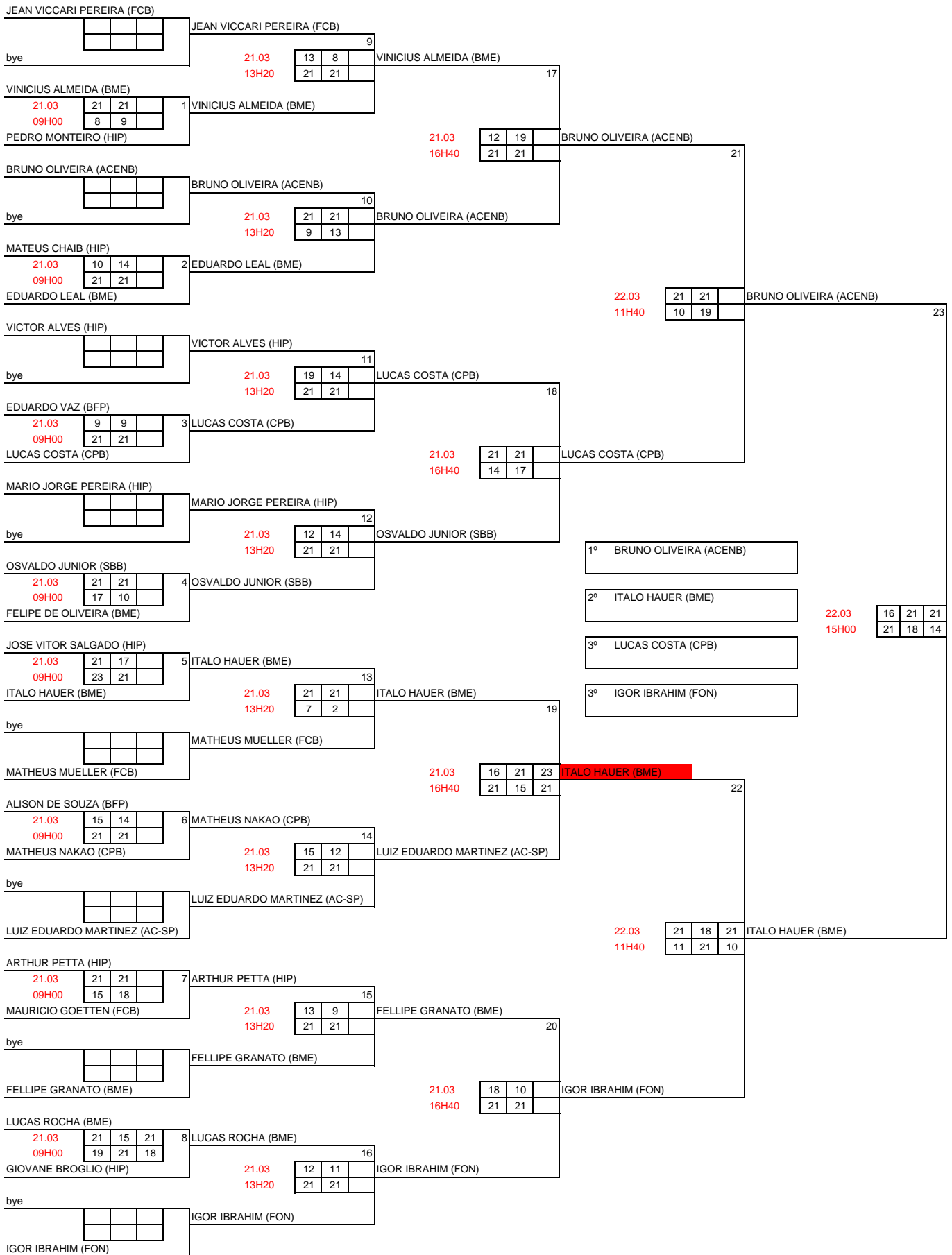

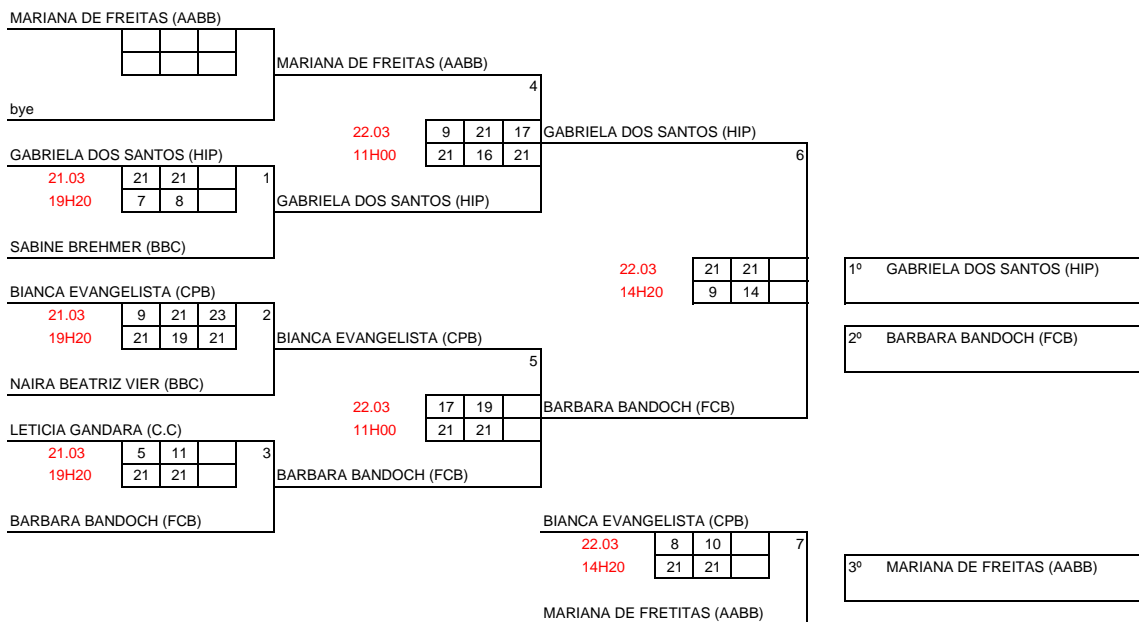

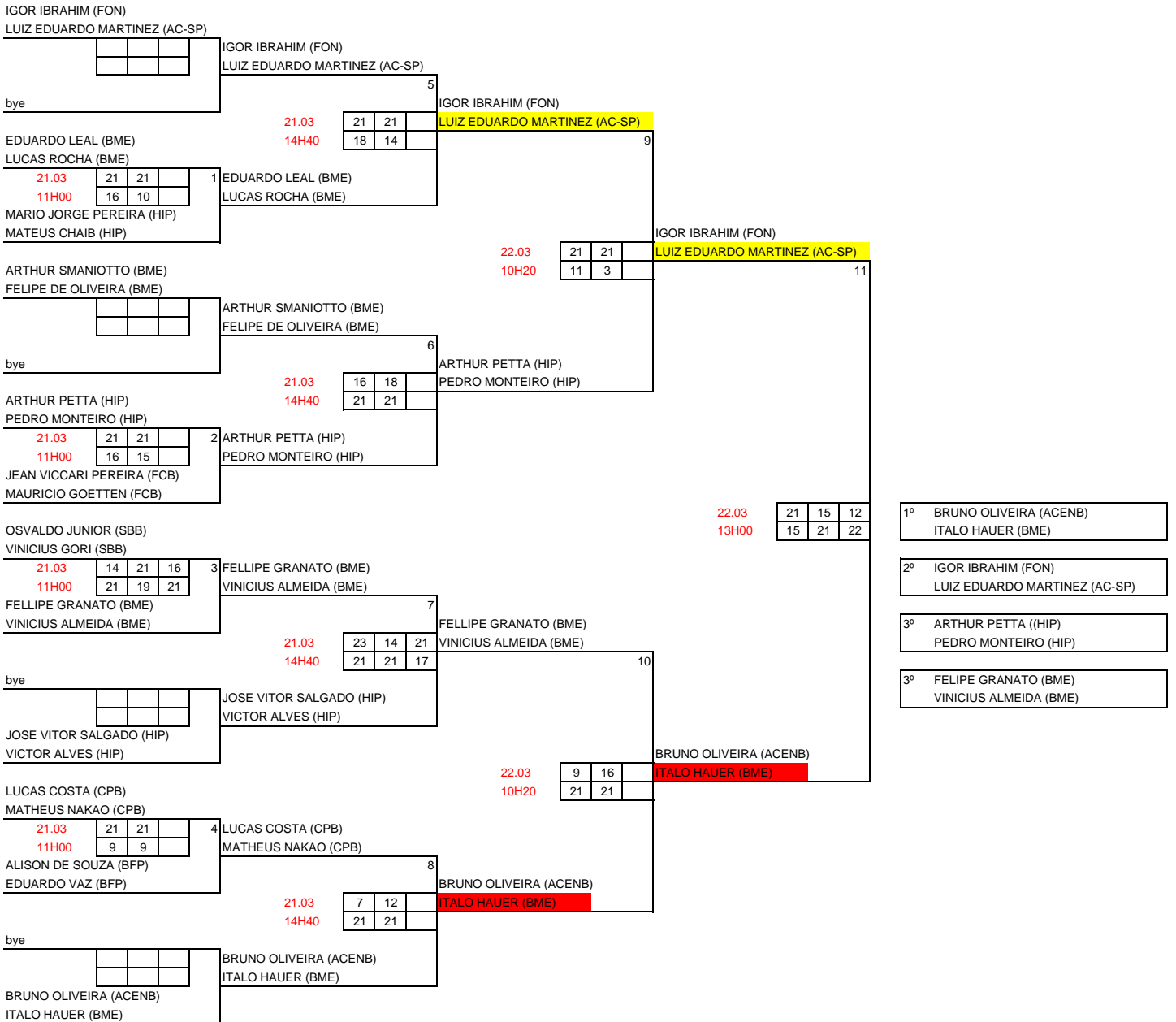

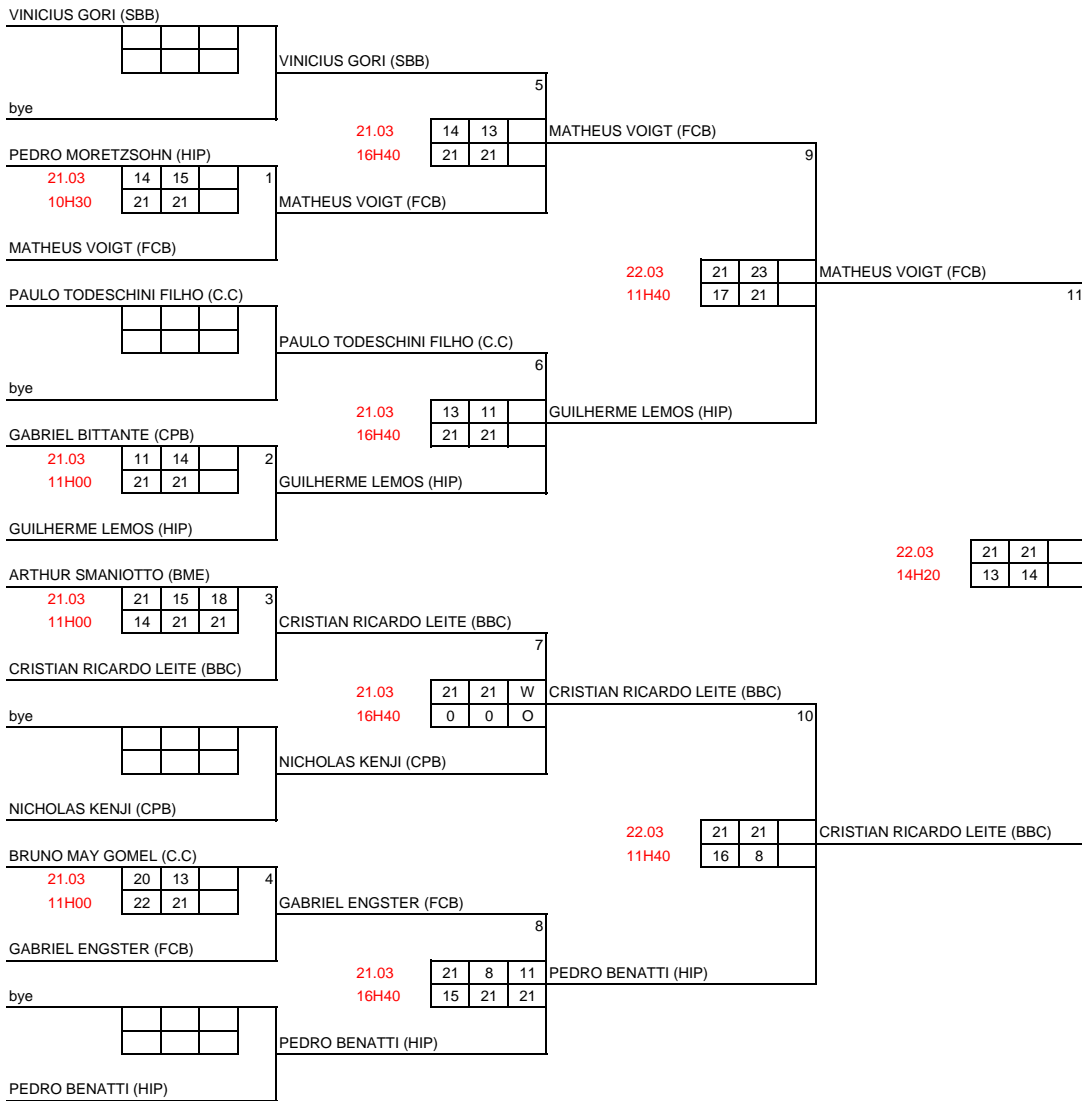

- 1º MATHEUS VOIGT (FCB)
- 2º CRISTIAN RICARDO LEITE (BBC)
- 3º GUILHERME LEMOS (HIP)
- 3º PEDRO BENATTI (HIP)

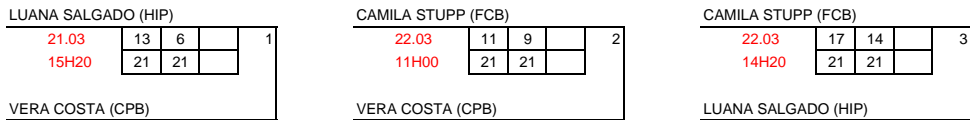

- 1º VERA COSTA (CPB)
- 2º LUANA SALGADO (HIP)
- 3º CAMILA STUPP (FCB)

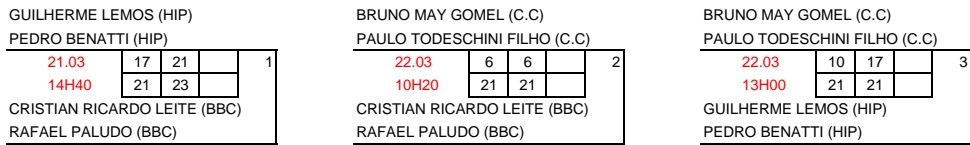

- 1º CRISTIAN RICARDO LEITE (BBC)
RAFAEL PALUDO (BBC)
- 2º GUILHERME LEMOS (HIP)
PEDRO BENATTI (HIP)
- 3º BRUNO MAY GOMEL (C.C)
PAULO TODESCHINI FILHO (C.C)

CAMPEONATO NACIONAL DE CURITIBA - ABERTO - 2009

DX Sub-13

21

LUANA SALGADO (HIP)
PEDRO MORETZSOHN (HIP)

21.03	21	24		1
20H00	19	22		

GABRIEL BITTANTE (CPB)
VERA COSTA (CPB)

CAMILA STUPP (FCB)
MATHEUS VOIGT (FCB)

22.03	21	12	21	2
09H00	13	21	4	

GABRIEL BITTANTE (CPB)
VERA COSTA (CPB)

CAMILA STUPP (FCB)
MATHEUS VOIGT (FCB)

22.03	22	21		3
13H40	20	10		

LUANA SALGADO (HIP)
PEDRO MORETZSOHN (HIP)

1º	CAMILA STUPP (FCB) MATHEUS VOIGT (FCB)
----	---

2º	LUANA SALGADO (HIP) PEDRO MORETZSOHN (HIP)
----	---

3º	GABRIEL BITTANTE (CPB) VERA COSTA (CPB)
----	--

CAMPEONATO NACIONAL DE CURITIBA - ABERTO - 2009

SM Sub-11

22

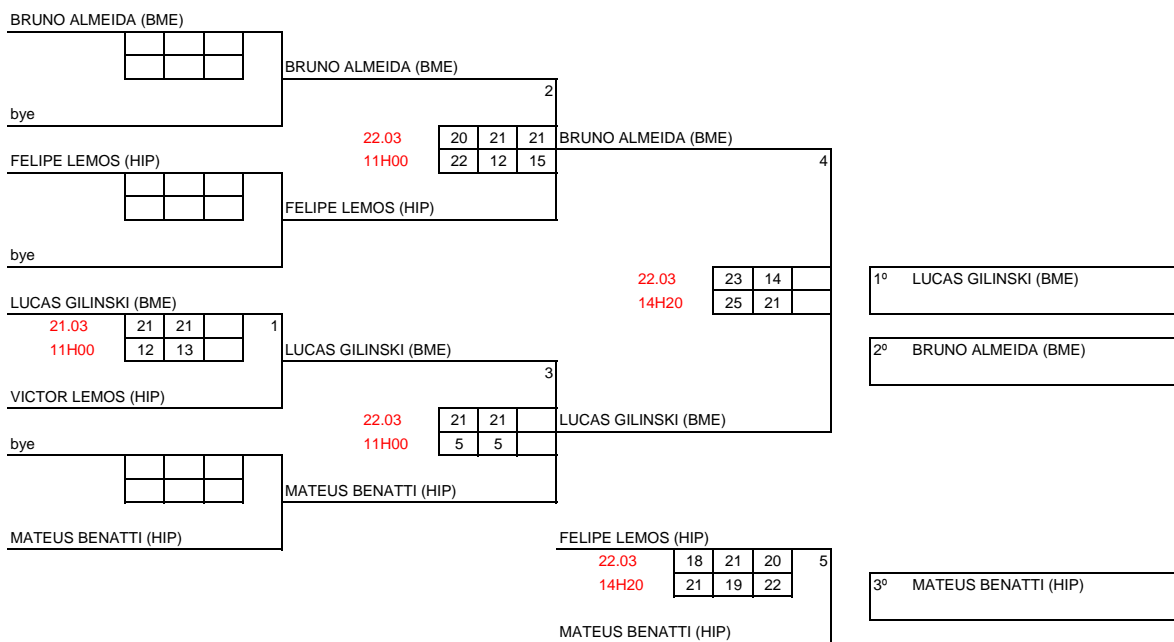

CAMPEONATO NACIONAL DE CURITIBA - ABERTO - 2009

DM Sub-11

23

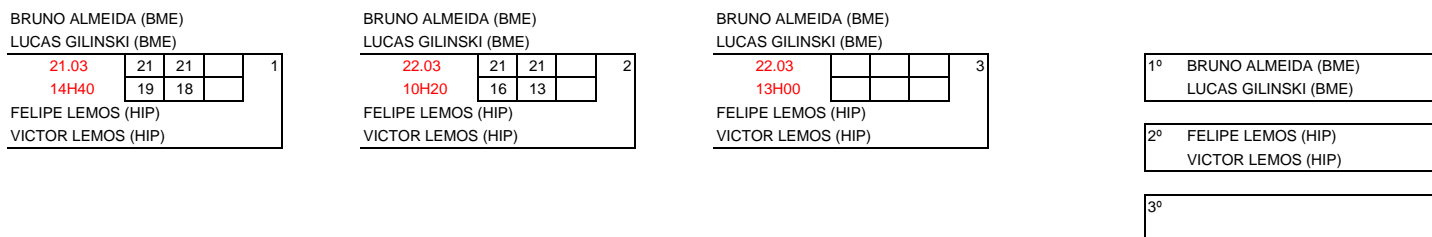

Quadro de Horários - 21 Março 2009

Horário	Quadra 01	Quadra 02	Quadra 03	Quadra 04	Quadra 05	Quadra 06	Quadra 07	Quadra 08	Horário
08:30	CONGRESSO TÉCNICO								08:30
09:00	SM S15 1	SM S15 2	SM S15 3	SM S15 4	SM S15 5	SM S15 6	SM S15 7	SM S15 8	09:00
09:30	SM S17 1	SM S17 2	SM S17 3	SM S19 1	SM S19 2	SM S19 3	SM1	SM2	09:30
10:00	SM3	SM4	SM5	SM6	SM7	SM8	SM9	SM10	10:00
10:30	SM11	SF1	SF2	SF3	SF4	SF5	SF6	SM S13 1	10:30
11:00	SM S13 2	SM S13 3	SM S13 4	DM S15 1	DM S15 2	DM S15 3	DM S15 4	SM S11 1	11:00
11:30	DM1	DM2	DM3	DM4	DM5				11:30
12:00	SM S17 4	SM S17 5	SM S17 6	SM S17 7	SM S17 8	SM S17 9	SM S17 10	SM S17 11	12:00
12:40	SM S19 4	SM S19 5	SM S19 6	SM S19 7	SM S19 8	SM S19 9	SM S19 10	SM S19 11	12:40
13:20	SM S15 9	SM S15 10	SM S15 11	SM S15 12	SM S15 13	SM S15 14	SM S15 15	SM S15 16	13:20
14:00	SM12	SM13	SM14	SM15	SM16	SM17	SM18	SM19	14:00
14:40	DF S19 1	DF S17 1	DM S15 5	DM S15 6	DM S15 7	DM S15 8	DM S13 1	DM S11 1	14:40
15:20	DM S19 1	DM S19 2	DM S19 3	DM S19 4	DM S17 1	DM S17 2	DM S17 3	SF S13 1	15:20
16:00	DM6	DM7	DM8	DM9	DF1	DF2	DF3	DF4	16:00
16:40	SM S15 17	SM S15 18	SM S15 19	SM S15 20	SM S13 5	SM S13 6	SM S13 7	SM S13 8	16:40
17:20	SM S17 12	SM S17 13	SM S17 14	SM S17 15	SF S17 1	SF S17 2	SF S17 3	SF S17 4	17:20
18:00	SM S19 12	SM S19 13	SM S19 14	SM S19 15	SF S19 1	SF S19 2	SF S19 3	SF S19 4	18:00
18:40	SM20	SM21	SM22	SM23	SF7	SF8	SF9	SF10	18:40
19:20	SF S15 1	SF S15 2	SF S15 3						19:20
20:00	DX1	DX2	DX S17 1	DX S13 1					20:00

Quadro de Horários - 22 Março 2009

Horário	Quadra 01	Quadra 02	Quadra 03	Quadra 04	Quadra 05	Quadra 06	Quadra 07	Quadra 08	Horário
09:00	DX3	DX4	DX S17 2	DX S13 2					09:00
09:40	DM S19 5	DM S19 6	DF S19 2	DF S19 3	DM S17 4	DM S17 5	DF S17 2		09:40
10:20	DM10	DM11	DF5	DF6	DM S15 9	DM S15 10	DM S13 2	DM S11 2	10:20
11:00	SF S17 5	SF S17 6	SF S15 4	SF S15 5	SF S13 2	SM S11 2	SM S11 3		11:00
11:40	SF S19 5	SF S19 6	SM S17 16	SM S17 17	SM S15 21	SM S15 22	SM S13 9	SM S13 10	11:40
12:20	SM24	SM25	SF11	SF12	SM S19 16	SM S19 17			12:20
13:00	DF S17 3	DM S17 6	DM S17 7	DM S15 11	DM S13 3	DM S11 3			13:00
13:40	DM12	DF7	DM S19 7	DF S19 4	DF S19 5	DX S17 3	DX S13 3		13:40
14:20	DX5	DX6	SF S15 6	SF S15 7	SM S13 11	SF S13 3	SM S11 4	SM S11 5	14:20
15:00	SM S15 23	SM S17 18	SF S17 7						15:00
15:40	SM28	SF13	SM S19 18	SF S19 7					15:40

16:20

PREMIAÇÃO

16:20